

BONALDO

Flame, Flame Wood

Designer: Gino Carollo



Flame è un tavolo da soggiorno di design dalle forme armoniche, leggero e sinuoso. Il piano sospeso è utilizzabile in tutto il suo spazio grazie al posizionamento del doppio basamento, studiato per ottimizzare lo spazio di ingombro. Forma e funzione trovano la loro massima espressione in questo tavolo: la vasta possibilità di personalizzazione permette di configurarlo secondo il proprio gusto, le proprie esigenze e lo stile dell'ambiente circostante. Il piano è disponibile in numerose e ricercate finiture - dal legno alla ceramica, fino al marmo - mentre per la base è possibile scegliere tra diverse varianti di metallo. Disponibile anche la versione con la base in legno, Flame Wood.



Scheda tecnica

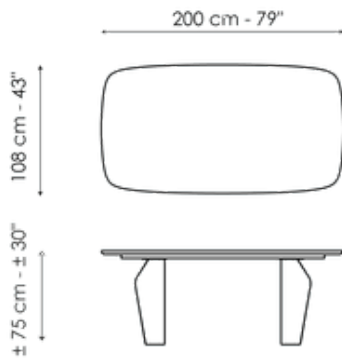

Larghezza: 200cm
Profondità: 108cm
Altezza: ± 75cm

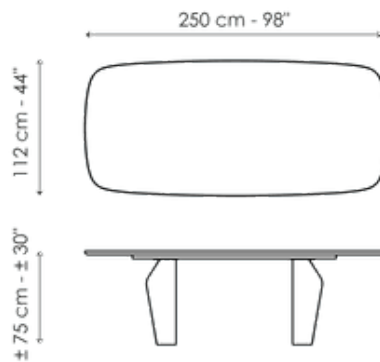

Larghezza: 250cm
Profondità: 112cm
Altezza: ± 75cm

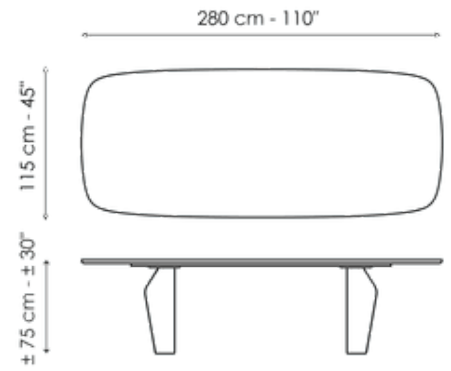

Larghezza: 280cm
Profondità: 115cm
Altezza: ± 75cm

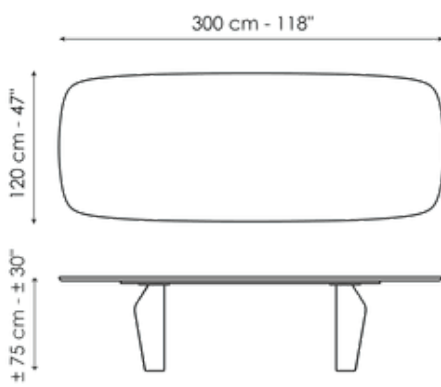

Larghezza: 300cm
Profondità: 120cm
Altezza: ± 75cm

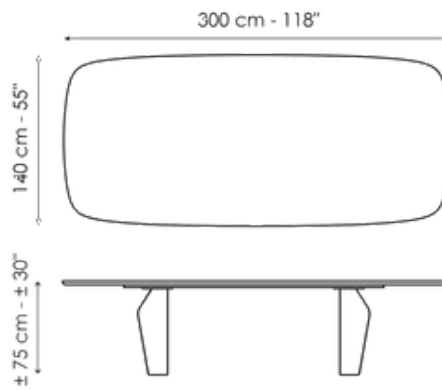

Larghezza: 300cm
Profondità: 140cm
Altezza: ± 75cm

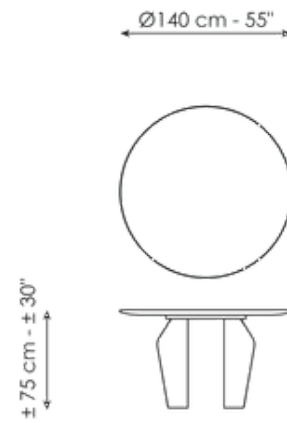

Larghezza: 140cm
Profondità: 140cm
Altezza: ± 75cm

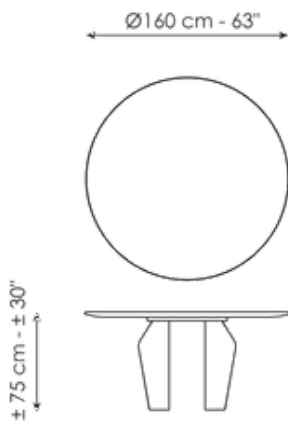

Larghezza: 160cm
Profondità: 160cm
Altezza: ± 75cm

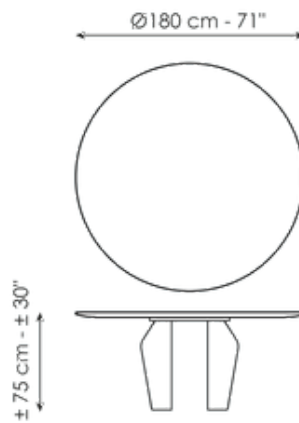

Larghezza: 180cm
Profondità: 180cm
Altezza: ± 75cm

Finishes

Piano a botte

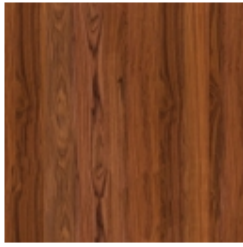

Legno massello
Noce americano

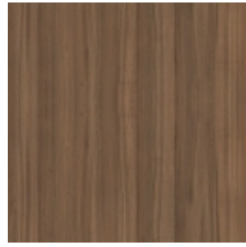

Legno impiallacciato
Noce Canaletto



Legno massello
Rovere spazzolato naturale



Legno massello
Rovere spazzolato carbone

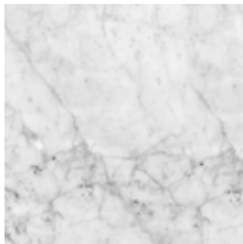

Marmo
Carrara

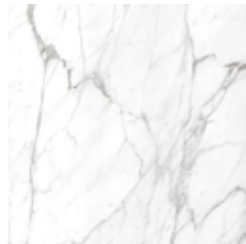

Marmo
Calacatta

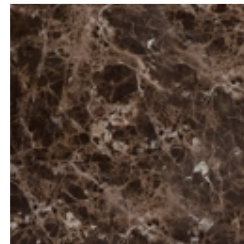

Marmo
Emperador

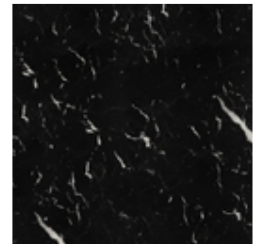

Marmo
Marquinia

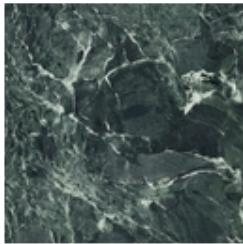

Marmo
Saint Denis



Marmo
Rosso Carpazi



Marmo
Fior di bosco



Marmo
Travertino Romano

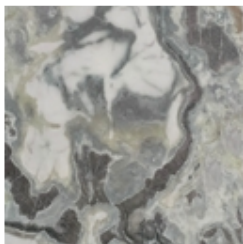

Marmo
Dover White

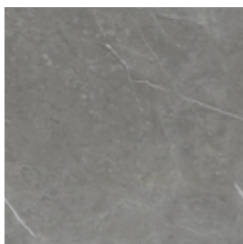

Ceramica opaca
Grigio Ardesia

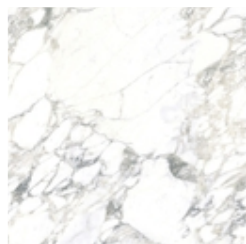

Ceramica lucida
Calacatta

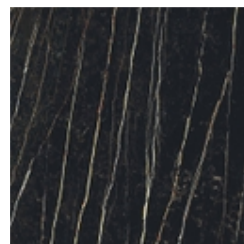

Ceramica opaca
Laurent



Ceramica finitura seta
Calacatta macchia vecchia

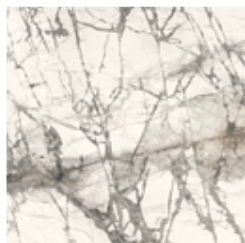

Ceramica lucida
Imperial grey

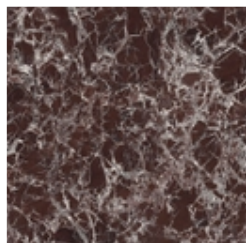

Ceramica lucida
Rosso imperiale

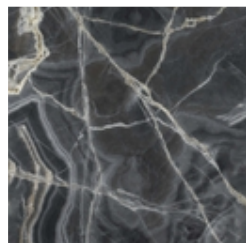

Ceramica lucida
Black Onyx

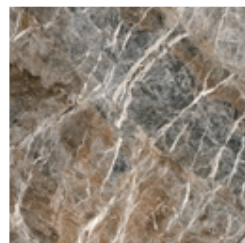

Ceramica lucida
Mountain peak

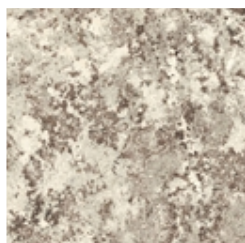

Ceramica opaca
Alaska White



Ceramica opaca
Augusta

Piano rotondo

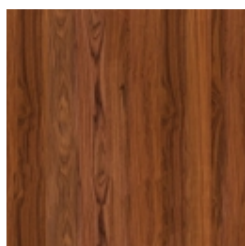

Legno massello
Noce americano

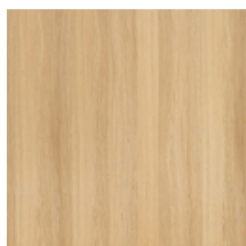

Legno massello
Frassino spazzolato naturale



Legno massello
Rovere spazzolato carbone

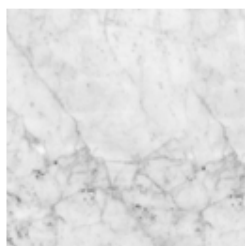

Marmo
Carrara

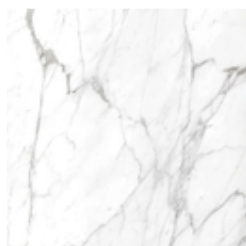

Marmo
Calacatta

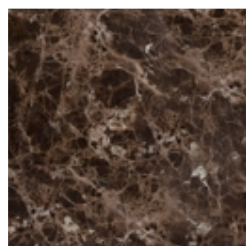

Marmo
Emperador

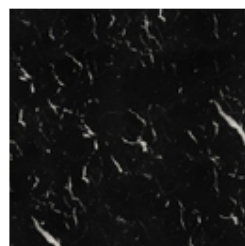

Marmo
Marquinia

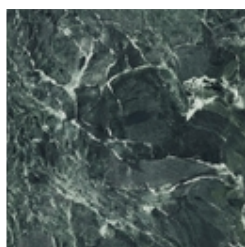

Marmo
Saint Denis

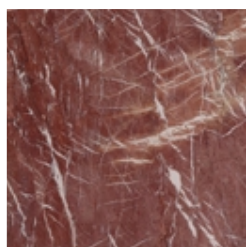

Marmo
Rosso Carpazi

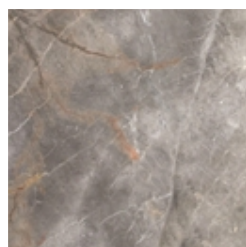

Marmo
Fior di bosco



Marmo
Travertino Romano

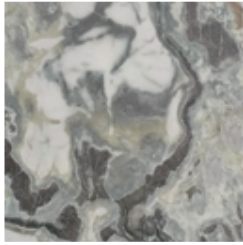

Marmo
Dover White

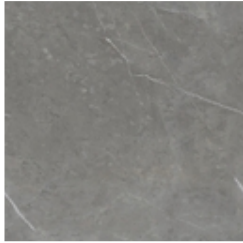

Ceramica opaca
Grigio Ardesia



Ceramica lucida
Calacatta

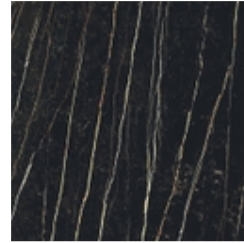

Ceramica opaca
Laurent



Ceramica finitura seta
Calacatta macchia vecchia

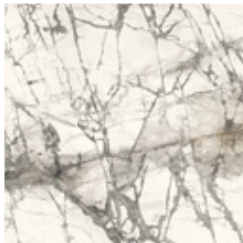

Ceramica lucida
Imperial grey

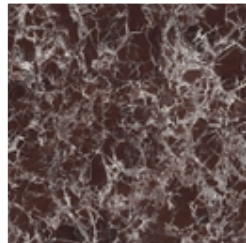

Ceramica lucida
Rosso imperiale

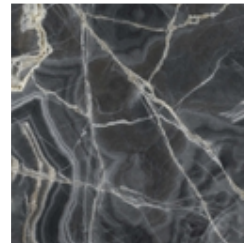

Ceramica lucida
Black Onyx

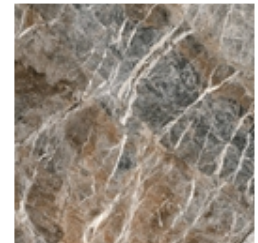

Ceramica lucida
Mountain peak

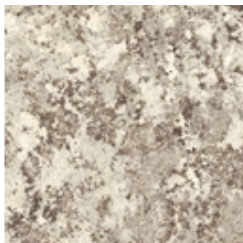

Ceramica opaca
Alaska White



Ceramica opaca
Augusta

Base

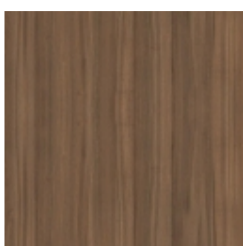

Legno impiallacciato
Noce Canaletto



Legno impiallacciato
Rovere carbone



Metallo finitura
Brunito



Metallo finitura
Clouded chrome



Metallo finitura
Brown nickel



Metallo finitura
Dark nickel



Metallo verniciato
Rame opaco



Metallo verniciato
Ottone opaco

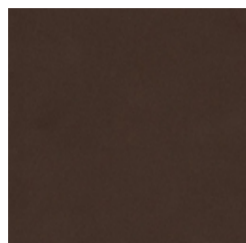

Metallo verniciato
Bronzo opaco

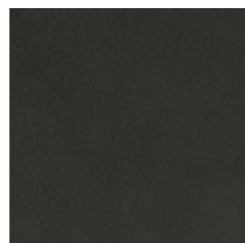

Metallo verniciato
Piombo opaco



Metallo verniciato
Oro perlato opaco

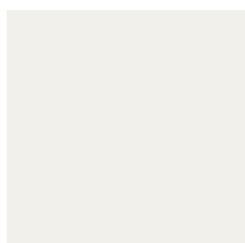

Metallo verniciato
Bianco opaco

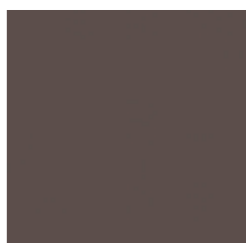

Metallo verniciato
Marrone opaco



Metallo verniciato
Supreme anthracite

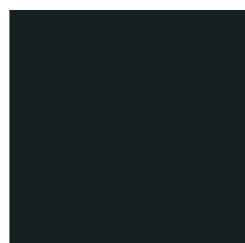

Metallo verniciato
Nero opaco



Metallo verniciato
Tortora opaco